

# PRODUCT OVERVIEW

# DISPLAY & CONTROL INSTRUMENTS

MAC Sensor Co.,LTD.  
Changsha City,Hunan,China  
<http://www.macsensor.com>

TEL: +86-731-89975636 / 89975645

# D8000 Series Multipurpose Colorful Data Paperless Recorder

(For Pressure, Level, Temperature, Humidity, Flow.... Data logger, display, record and Control)



## I. Overview

D8000 series Color paperless recorder can input signals, such as standard voltage, standard current, thermoelectric couple, resistance temperature detector and millivolt, etc; it can be based on 18-channel alarm output or 12-channel analog quantity output, RS232/485 communication interface, Ethernet interface, mini-printer interface, USB interface and SD card socket; sensor distribution can be provided; it is characterized by powerful display function, real-time curve display, historical curve recall, bar graph display and alarm list display, as well as humanized appearance design, perfect function, reliable hardware quality, exquisite manufacturing technique and higher cost performance, etc.

## II. Technical parameters

<b>Measurement input</b>	
Input signal	Current: 0-20mA,0-10mA, 4-20mA, 0-10mA evolution, 4-20mA evolution
	Voltage: 0-5V,1-5V,0-10V, $\pm 5V$ , 0-5V evolution, 1-5Vevolution, 0-20 mV, 0-100mV, $\pm 20mV$ , $\pm 100mV$
	Resistance thermometer detector: Pt100, Cu50, Cu53, BA1, BA2 linear resistance: 0-400 $\Omega$
	Thermoelectric couple: B, S, K, E, T, J, R, N, F2, Wre3-25 and Wre5-26
<b>Output</b>	
Output signal	Analog output: 4-20mA (load resistance $\leq 380\Omega$ ), 0-20mA (load resistance $\leq 380\Omega$ ), 0-10mA (load resistance $\leq 760\Omega$ ), 1-5V (load resistance $\geq 250K\Omega$ ), 0-5V (load resistance $\geq 250K\Omega$ ) and 0-10V (load resistance $\geq 500K\Omega$ )
	Alarm output: Normally-open output of relay, contact capacity1A/250VAC (Resistive load)
	Feed output: DC24V $\pm 1$ , load current $\leq 250mA$
	Communication output: RS485/RS232 communication interface, baud rate1200-57600bps(settable). The standards are listed as follows: MODBUS RTU communication protocol, maximum RS-485 communication distance: 1km; maximum RS-232 communication distance: 15m; Ethernet communication interface, communication speed10M, (merely applicable to Local Area Network)
<b>Composite parameters</b>	
Measurement accuracy	0.2%FS $\pm 1d$
Sampling period	1second
Setting mode	Light-touch key setting; password locking of parameter setting value; permanent saving of setting value outage.
Display mode	7-inch 800*480 dot matrix widescreen, TFT high-brightness color graphic LCD, LED backlight, clear display and wide visual angle. The screen brightness is adjustable. The display contents consist of Chinese characters, figures, process curves and bar graphics. By pressing the key on the panel, you can complete page turning, historical data search and modification of curve time scale, etc.
Data backup	Support USB and SD card for data backup and transfer, maximum capacity: 8GB, support FAT and FAT32 formats.

Storage capacity	Internal Flash storage capacity: 64M Byte
Time interval of recording	Time interval for selection: 1, 2, 4, 6, 15, 30, 60, 120, 240 ( Unit: second)
Time duration of storage (Continuous record without power failure)	4days ( 1-second time interval )—5825 days ( 240-second time interval ) Formula: $\text{Recordingtime(days)} = \frac{64 \times 1024 \times 1024 \times \text{time interval of recording (S)}}{\text{Number of channel} \times 2 \times 24 \times 3600}$ (! Note: Calculation of channel number: The program will divide the channel into five classes of 4, 8, 16, 32 and 64. When the channel number falls within the range of two classes, the bigger one should be taken. If, for instance, the channel number is 12, the number of 16 should be taken as the channel number.)
Operating environment	Environmental temperature: -10-50℃; relative humidity: 10-90%RH (no condensation); preventing strong corrosive gases. (! Note: Please state the special instructions when placing an order in case of severe environmental conditions on the site)
Working power	AC85-264V (switch power) , frequency range: 50-60Hz , maximum power consumption: 20VA

### III. Matters needing attention and installation

#### 3.1. Matters needing attention

##### 3. 1. 1 Matters needing attention during operation

- Because there are a great many plastic parts in the instrument, please use dry, soft cloth for wiping instead of benzene agent or banana oil, which can cause discoloration or deformation.
- Please don't make the electric product close to the signal terminal, which can cause failure.
- Please don't make the instrument vulnerable to shock.
- In case the instrument smokes and lets out abnormal smell with peculiar smell, cut off the power and then contact the supplier or our company immediately.
- To ensure the normal operation of the instrument, please power on the instrument and keep heating for 30 minutes beforehand.

##### 3. 1. 2 Matters needing attention of external storage medium

- Storage medium is a sophisticated product, so attention should be paid to operation.
- The operating cover should be closed in the running mode except the inserting and removal of the storage medium. Touch with the storage medium and the USB interface should be minimized for the sake of protection.
- During the operation of USB and SD card, attention should be paid to static protection.
- It is recommended that the product from the company should be used.
- When using the storage medium in high temperature (above 40℃ or so) and saving data, please insert the storage medium. Then take it out and put it away to avoid being inserted on the instrument for a long time.
- When switching on/off power, please take out the storage medium.
- For the general matters needing attention of the storage medium, refer to the operating instructions.

### 3. 2 Instrument installation

#### 3. 2. 1 Installation site

It should be installed at the following places:

- **Subpanel:**

The instrument is a panel mounting one

- **Installation place:**

It should be installed indoors to avoid wind, rain and sunshine.

- **Well ventilation:**

To prevent the internal temperature from rising, it should be installed at a well-ventilated place.

- **Infrequent mechanic vibration**

It should be installed at a place with infrequent mechanic vibration

- **Horizontal:**

It should be installed horizontally without leaning to the left or right. (Maximum 30° backwards).

---

! Note:

★ Move the instrument from the place with low temperature and humidity to the place with high temperature and humidity. In case that the temperature changes a lot, condensing may occur occasionally. Error will also occur if the thermoelectric couple is input. At the time, operation should not begin until the instrument has been placed in the surrounding environment for over 1 hour.

★ In case the instrument has been placed in the high-temperature place for a long time, the LCD service life will eventually be shortened (picture quality reduction, for instance). Therefore, the high-temperature environment should be avoided as far as possible (about above 40°C).

---

**The following places should be avoided:**

- **A place which can be affected by sunshine and the thermal device nearby**

Please choose the place with slight temperature change and near the normal temperature (23°C) as far as possible. Otherwise the inside of the instrument will be adversely influenced.

- **A place with much oily fume, vapor, dampness, dust and corrosive gas**

Such kind of place can affect the instrument.

- **Place nearby the electromagnetic source**

The magnetic device or magnet should not be placed near the instrument. Otherwise error will occur due to the influence of the magnetic field. To avoid abnormality, at least 20cm should be kept between the radio frequency generator and the instrument during operation.

- **Place with poor visual effect**

Equipped with 7-inch TFT true color LCD, the screen will be invisible from an extreme deflection angle.

So it should be installed at a place visible from the front side as far as possible.

#### 3. 2. 2 Installation method

- **Installation dimension (Unit: mm)**

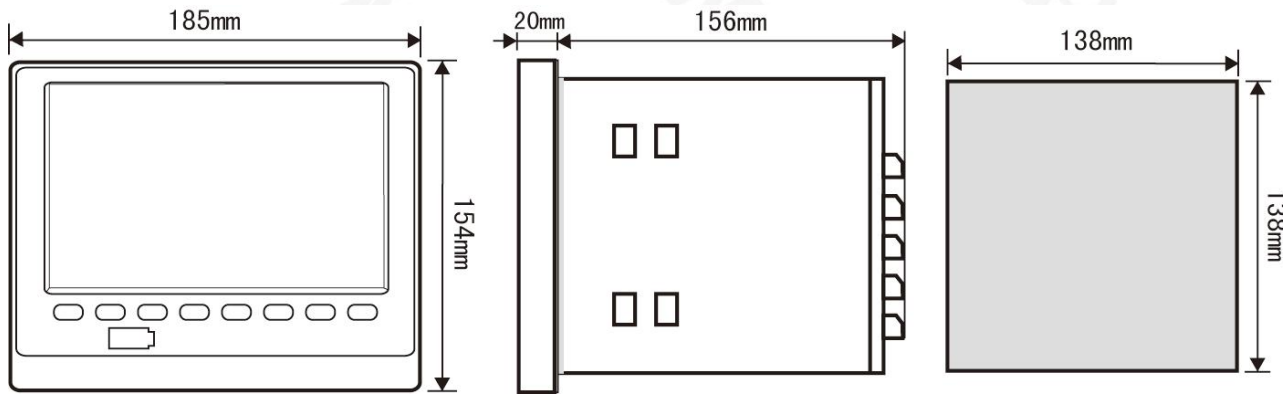

### ●Installation of instrument

#### (1) Installation method

A. Input the instrument from the front of the panel

B. Install the instrument according to the installing support attached to the instrument as shown below:

▲Fix four installing supports to the two sides of the instrument

(2) For the installation, refer to the right diagram

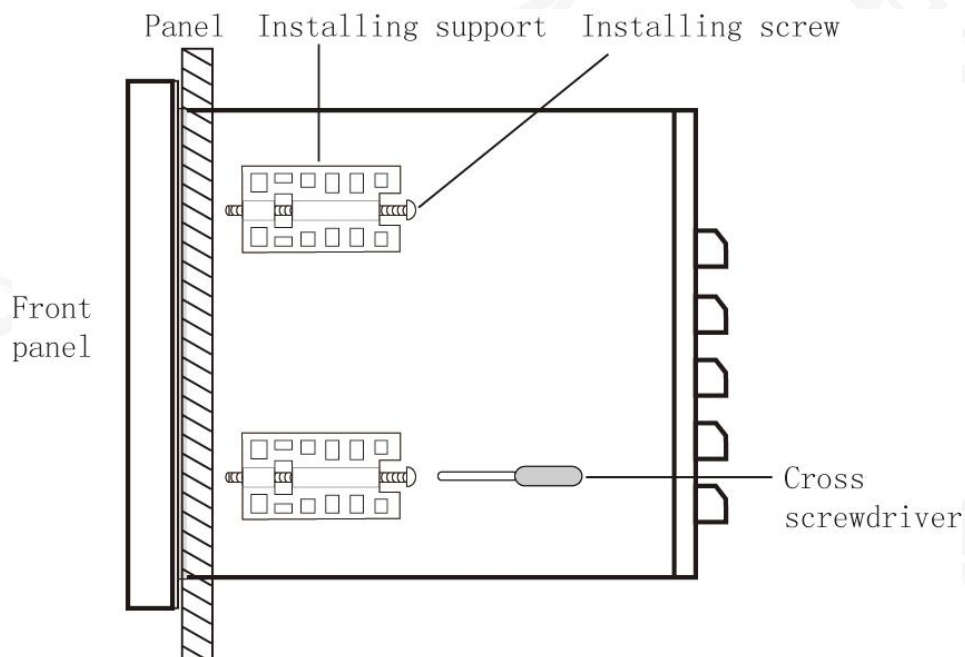

### ●Wiring diagram

Terminal diagram of instrument tail

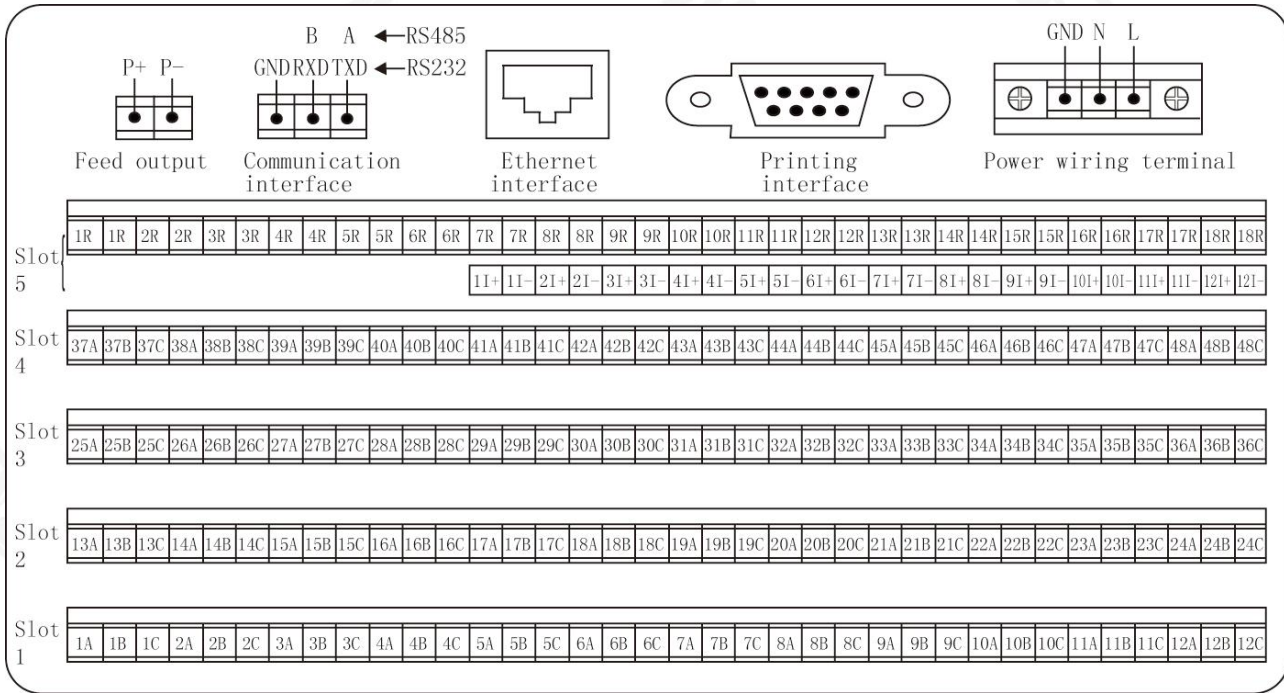

Wiring that

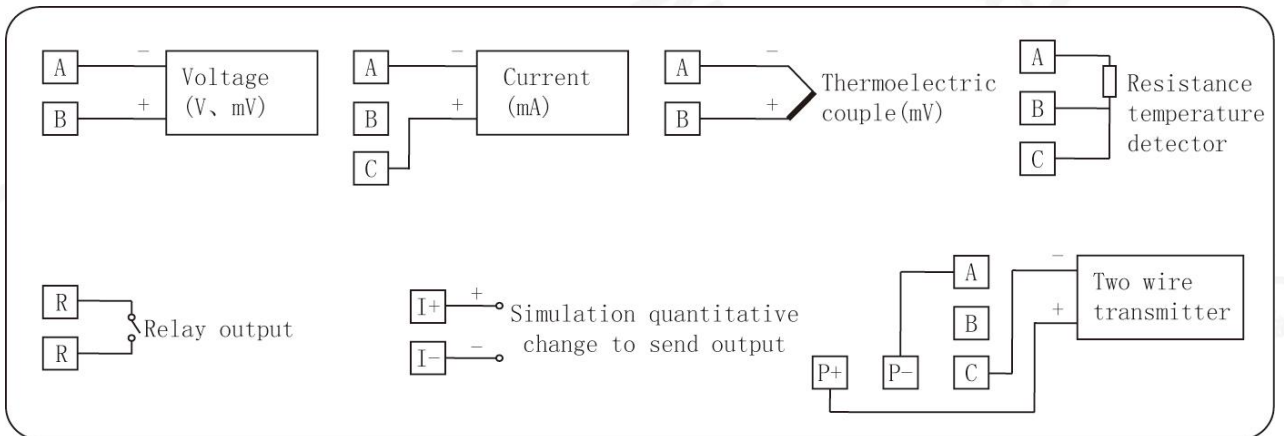

IV. Ordering Instruction

D87□-□-□-□-□

48-channel input ① ② ③ ④ ⑤

① Number of Input Channel		② Number of Transmitting Output Channel (remark)	
Code	Input channel	Code	Output channel

01	1-channel input	X	No output
02	2-channel input	01	1-channel output
03	3-channel input	02	2-channel output
.	.	03	3-channel output
.	.	.	.
.	.	.	.
47	47-channel input	.	.
48	48-channel input	11	11-channel output
		12	12-channel output
③ Number of Alarm Output Channel (remark)		④ Power Supply	
Code	Alarm channel	Code	Voltage range
X	No output	A	AC85 ~ 264V (50/60 HZ)
01	1-limit alarm	D	DC12 ~ 36V
02	2-limit alarm		
03	3-limit alarm		
.	.		
.	.		
.	.		
17	17-limit alarm		
18	18-limit alarm		
⑤ Additional functions (You can select all the following functions with "/" to separate them, and can omit the unselected functions.)			
Communication output		USB conversion storing function	
Code	Type of communication output	Code	USB conversion storage
D1	RS485 communication	U	USB conversion storage (USB flash disk)
D2	RS232 communication		
Print function		SD card extended function	
Code	Print interface	Code	SD card extension
D3	RS232C print	SD	SD card extension (SD card)
Feed output		Ethernet communication function	
Code	Feed output	Code	Ethernet communication
P	DC24 V	E	Ethernet communication

Remark 1: D8700 recorder is equipped with optional 48-channel input.

2: Number of analog output channels + number of relay output channels  $\leq$  18.

## V. Function and operation

Paperless Recorder large information content and convenient configuration, the multi-channel temperature controller is equipped with multiple operating display screens and configuration screens.

Therefore, the user can operate the instrument without training. Power on the instrument and display the

initial picture of the system and then enter the digital picture after the completion of system initialization. Various display pictures and configuration pictures are described as follows:

## 5. 1 Switching of running screen

The running screen consists of real-time curve picture, bar graphics, digital display picture, historical curve picture, alarm list, file list, printing graphics, backup picture, power-off recording screen and configuration parameter.

The switching between the screens should be based on the "Switch" key.

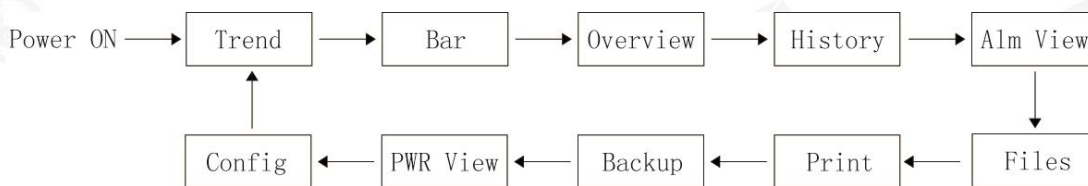

## 5. 2 Part of status display

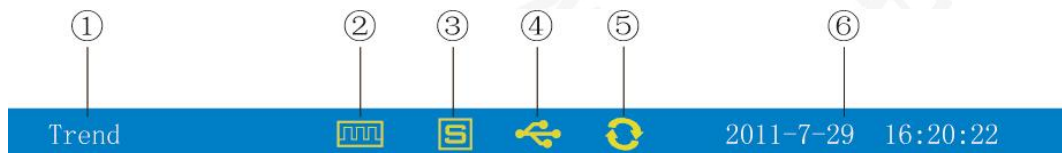

- ①: Name of each running screen
- ②: Display of file record mark: It means that the file is recording  
 Display with arrow mark: It means that the SD card is in the backup process.  
 No display: It means that the file has stopped recording.
- ③: Display of SD card mark: It means that the SD card has been connected.  
 No display: It means that the SD card has not been connected.
- ④: Display of USB mark: It means that the USB has been connected  
 No display: It means that no USE has been connected to the instrument.
- ⑤: Display of circular mark: It means that each configuration is being displayed.  
 No display: It means that the picture is fixed without circular display.
- ⑥: Running date and time display of the instrument

## 5. 3 Real-time curve picture

According to the setting of curve combination, the real-time curve and data of six channels will be displayed at the same time (curve accuracy: 0.5%±1 character).

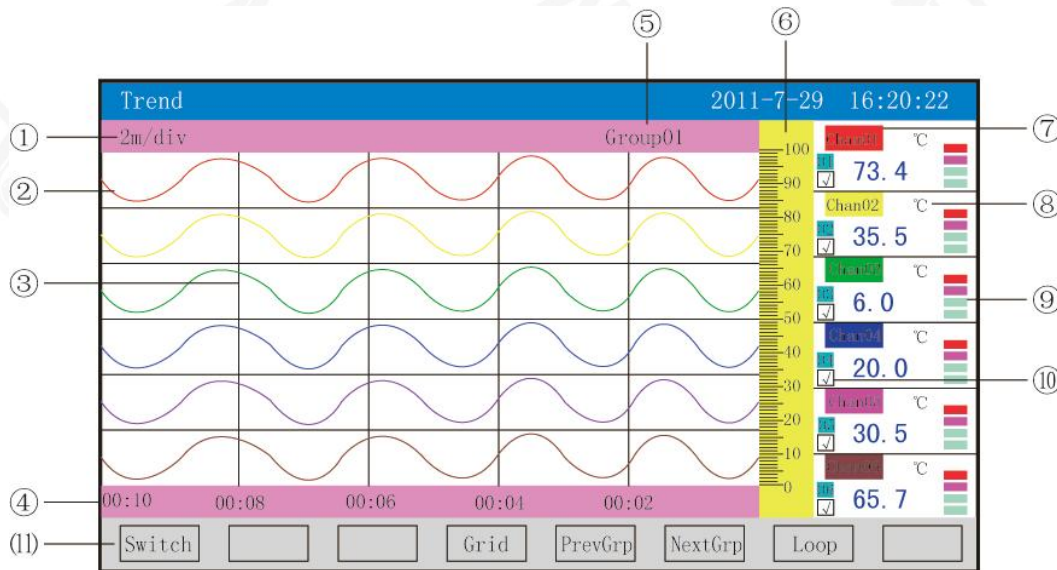

①: Time scale: Time duration of each grid. Time scale is connected with time interval. For more information, refer to the following table:

Record time interval	1 second	2 second s	4 second s	6 second s	15 second s	30 second s	1 minute	2 minute s	4 minut es
Time scale	2minut e/grid	4minute /grid	8minute /grid	12minu te/grid	30minut e/grid	1hour/g rid	2hours/grid	4hours/ grid	8hour s/grid
	4minut es/grid	8minute s/grid	16minut es/grid	24minu tes/grid	1hour/g rid	2hours/ grid	4hours/grid	8hours/ grid	16hou rs/grid
	8minut es/grid	16minut es/grid	32minut es/grid	48minu tes/grid	2hours/ grid	4hours/ grid	8hours/grid	16hour s/grid	32hou rs/grid
	16minu tes/grid	32minut es/grid	64minut es/grid	96minu tes/grid	4hours/ grid	8hours/ grid	16hours/gri d	32hour s/grid	64hou rs/grid

②: Data curve: At most 6 curves can be displayed on the same screen. (The six curve colors can be set by displaying configuration.)

③: Grid: It can be convenient for the user to estimate time and data.

④: Current time represented by the grid

⑤: Curve combination: Display the name of current curve combination (Each curve combination consists of 6 curves at most and, according to the requirements, the user can put relevant channel in a curve combination to provide convenience for data comparison between channels.)

⑥: Measuring scale: Percentile scale for curve display

⑦: Name of channel: The name can be set. The background color and the corresponding curve color should share the same one. (For the setting method, refer to Section 5.12.4.1 Input Method of Channel Location Number.)

⑧: Unit: Display the unit of the channel data (settable). (For the setting method, refer to Section 5.12.4.2 Input Method of Channel Unit.)

⑨: Indication of limit alarm: From the top to the bottom, each diamond refers to high-high limit, high limit, low limit and low-low limit. Gray means no alarm function; green means no alarm has been given; red/pink means an alarm.

⑩: Curve display/hidden mark: “√” means curve. Otherwise the curve is hidden.

⑪: Operating key:

Press the “Switch” to switch to other display pictures.

Press “Time Scale”to switch time scale.

Press “Previous”to check the previous curve combination.

Press “Next” to check the next curve combination

If you press “Cycle”, the “↻” circular icon will appear on the screen; if you press the circular time interval in the display combination, it will switch to the next curve combination automatically.

## 5. 4 Bar graphics

The six channel data and percentile bar graphics can be displayed at the same time.

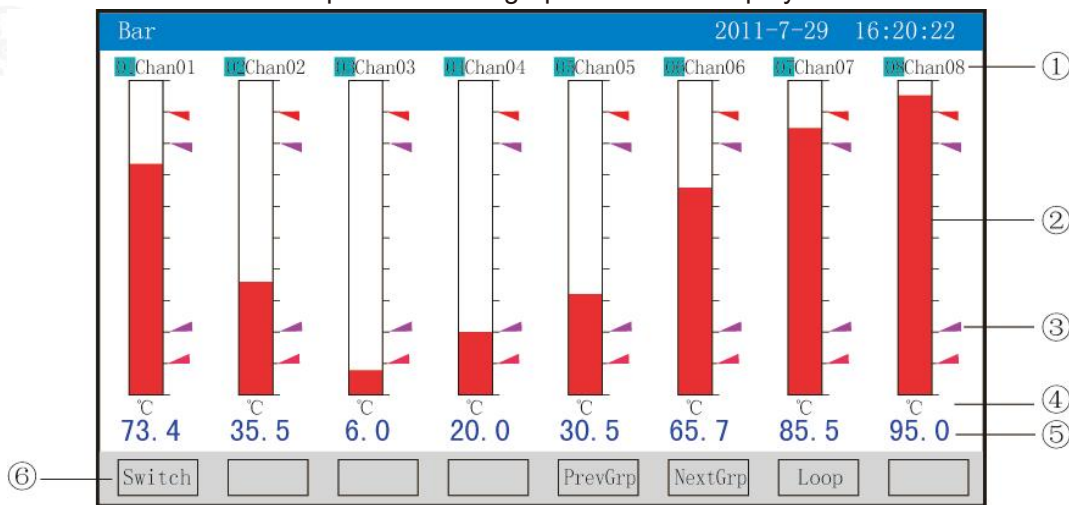

①: Name of channel: It means the corresponding engineering location number of the channel (settable). (For the setting method, refer to Section 5.12.4.1 Input Method of Channel Location Number.)

②: Bar graphics: The scale of bar graphics can be divided into 10 grids. The filling length of the color lump means the percentage of the measured value of the range. Blue means that the value is not in the alarm mode and red in the alarm mode.

③: Alarm mark: High-high alarm mark, turning red means limit alarm High alarm mark, turning pink means limit alarm low alarm mark, turning pink means limit alarm Low-low alarm mark, turning red means limit alarm.

④: Unit: Display the unit of the channel data (settable). (For the setting method, refer to Section 5.12.4.2 Input Method of Channel Unit.)

⑤: Data of work amount: It is the current data of work amount. Blue means the measured value cannot meet the demand of alarm output and red meets the demand of alarm output.

⑥: Operating key:

Press “Switch” to switch to other display pictures automatically;

press “Previous”to check the previous bar graphic combination;

press “Next”to check the next bar graphic combination.

If you press “Cycle”, the “↻” circular icon will appear on the screen; if you press the circular time interval in the display combination, it will switch to the next bar graphic combination automatically.

## 5. 5 Digital pictures

Multiple real-time data and alarm statuses can be displayed at the same time.

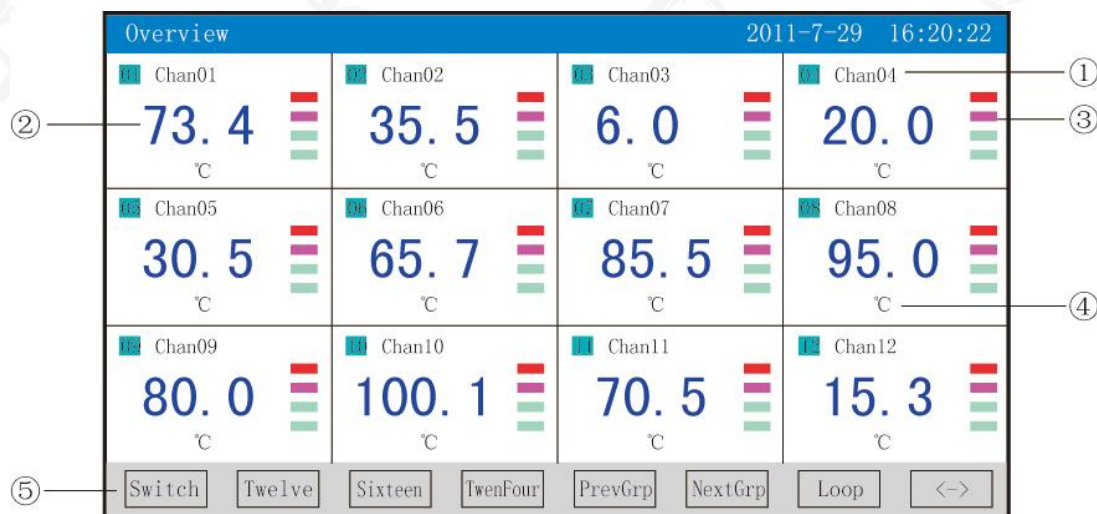

①: Name of channel: Display the engineering location number of the channel (settable). (For the setting method, refer to Section 5.12.4.1 Input Method of Channel Location Number.)

②: Data of work amount: Current data of work amount.

③: Indication of limit alarm: From the top to the bottom, each diamond refers to high-high limit, high limit, low limit and low-low limit. Gray means no alarm function; green means no alarm has been given; red/pink means an alarm.

④: Unit: Display the unit of the channel data (settable). For the setting method, refer to Section 5.12.4.2 Input Method of Channel Unit.)

⑤: Operating key:

Press "Switch" to switch to other pictures;

press "<->" to display to switch show scenes of poems, "Channel 2, Channel 4, Channel 6, Channel 12, Channel 16, Channel 24, "

press "Channel 2" to display location number, data of work amount, alarm status and engineering unit of Channel 2 at the same time;

press "Channel 4" to display location number, data of work amount, alarm status and engineering unit of Channel 4 at the same time;

press "Channel 6" to display location number, data of work amount, alarm status and engineering unit of Channel 6 at the same time;

press "Channel 12" to display location number, data of work amount, alarm status and engineering unit of Channel 12 at the same time;

press "Channel 16" to display location number, data of work amount, alarm status and engineering unit of Channel 16 at the same time;

press "Channel 24" to display location number, data of work amount, alarm status and engineering unit of Channel 24 at the same time;

press "Previous" to check the previous digital combination.

Press "Next" to check the next digital combination

If you press "Cycle", the "🔄" circular icon will appear on the picture; if you press the circular time interval in the display combination, it will switch to the next digital display combination automatically.

## 5. 6 Historical curve pictures

According to the setting of the curve combination, the historical data curve of six channels can be displayed at the same time (curve accuracy: 0.5%±1 character).

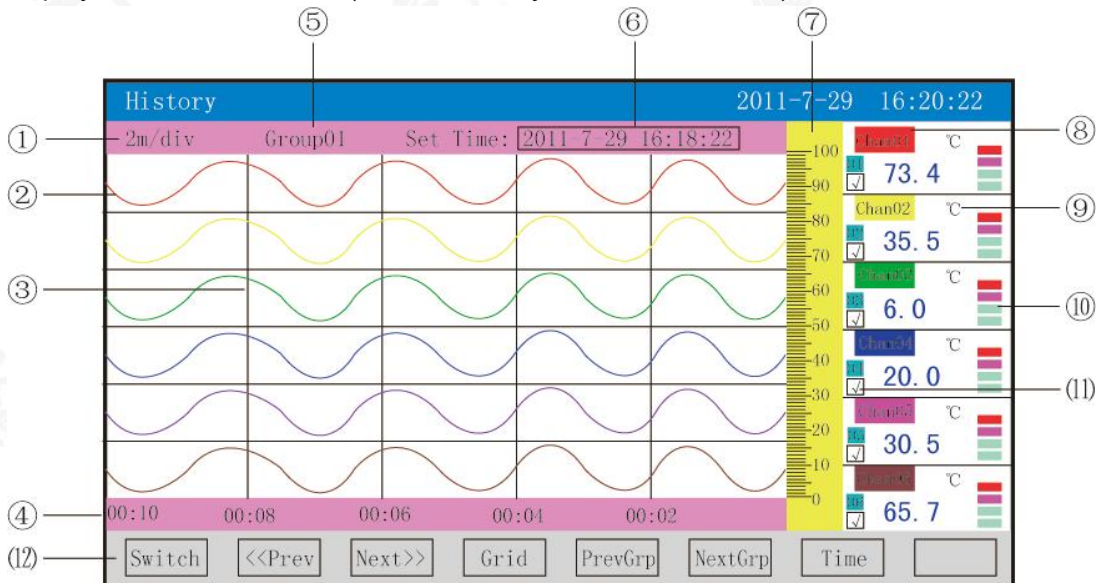

- ①: Time scale: Time duration of each grid. Time scale is connected with recording time interval. For more information, refer to the description of real-time curve picture.
- ②: Data curve: At most six curves can be displayed on the same screen at the same time. (The six curve colors can be set through the display configuration.)
- ③: Grid: Convenient for the user to estimate time and data.
- ④: Time of the current grid
- ⑤: Curve combination: Display the name of the current curve combination (Each curve combination consists of 6 curves at most and, according to the requirements, the user can put relevant channel in a curve combination to provide convenience for data comparison between channels)
- ⑥: Recall time: "Year-month-day Hour-minute-second"
- ⑦: Time scale: Display the percentile scale of the curve.
- ⑧: Name of channel: Settable. For the setting method, refer to Section 5.12.4.1 Input Method of Channel Location Number. The background color and the corresponding curve color should share the same one.
- ⑨: Unit: Display the unit of the channel data (settable). For the setting method, refer to Section 5.12.4.2 Input Method of Channel Unit.
- ⑩: Indication of limit alarm: From the top to the bottom, each diamond refers to high-high limit, high limit, low limit and low-low limit. Gray means no alarm function; green means no alarm has been given; red/pink means an alarm.
- ⑪: Curve display/hidden mark: "√" means curve, otherwise the curve is hidden.
- ⑫: Operating key:  
 Press "Switch" to switch to other pictures;  
 press "<<Prev" to recall data forwards based on the current recall time;  
 press "Next>>" to recall data backwards based on current recall time;  
 press "Time Scale" to switch time scale;  
 press "Previous" to check the previous curve combination;  
 press "Next" can to check the next curve combination;

press "Time" can to recall time "Year-month-day Hour-minute-second".

## 5. 7 Alarm list picture

The alarm list picture can display the channel alarm message and the output status of relay. At most 100 messages can be saved. Then the new alarm record will cover the earliest one.

Alm View							2011-7-29 16:20:22	
No.	Chan	Name	Alarm Time	Clear Time		Type		
013	01	Chan01	2011-7-29 16:00:22	2011-7-29	16:00:22	H		
012	01	Chan01	2011-7-29 16:01:22	2011-7-29	16:01:22	HH		
011	01	Chan01	2011-7-29 16:02:22	2011-7-29	16:02:22	H		
010	01	Chan01	2011-7-29 16:03:22	2011-7-29	16:03:22	HH		
009	01	Chan01	2011-7-29 16:04:22	2011-7-29	16:04:22	H		
008	01	Chan01	2011-7-29 16:05:22	2011-7-29	16:05:22	HH		
007	01	Chan01	2011-7-29 16:06:22	2011-7-29	16:06:22	H		
006	01	Chan01	2011-7-29 16:07:22	2011-7-29	16:07:22	HH		
005	01	Chan01	2011-7-29 16:08:22	2011-7-29	16:08:22	H		
004	01	Chan01	2011-7-29 16:09:22	2011-7-29	16:09:22	HH		
003	01	Chan01	2011-7-29 16:10:22	2011-7-29	16:10:22	H		
002	01	Chan01	2011-7-29 16:11:22	2011-7-29	16:11:22	HH		
001	01	Chan01	2011-7-29 16:12:22	2011-7-29	16:12:22	H		
01R 02R 03R 04R 05R 06R 07R 08R 09R 10R 11R 12R 13R 14R 15R 16R 17R 18R								
Switch <input type="checkbox"/> Up <input type="checkbox"/> Down <input type="checkbox"/> PgUp <input type="checkbox"/> PgDn <input type="checkbox"/> <input type="checkbox"/>								

①: Number: Serial number of the alarm. The alignment is on the time basis. The nearer the time is, the bigger the serial number is.

②: Channel: Input channel number of the alarm

③: Location number: The corresponding location number of the alarm input channel

④: Alarm time: Starting time of alarm

⑤: Alarm removal time: Ending time of alarm

⑥: Type of alarm: High-high alarm (HH), high alarm (H), low alarm (L), low-low alarm (LL)

⑦: Relay status: From the left to the right are the current statuses of 1—18 limit relays. Green means that the relay contact is disconnected and read closed.

⑧ Operating key:

Press "Switch" to switch to other pictures;

Press "Up" to check the alarm list upwards;

Press "Down" to check the alarm list downwards;

Press "PgUp" to check the alarm list upwards;

Press "PgDn" to check the alarm list downwards.

Remarks: The list-screen displays 13 alarm records.

## 5. 8 File List Screen

The file list screen can display file storage message and status of file storage. At most 100 messages can be saved. Then the new record file will cover the earliest one.

No.	Start Time	End Time	Int	Cond	Status
006	2011-7-29 15:30:40	2011-7-29 15:31:00	1S	Pwr	Recording
005	2011-7-29 15:30:10	2011-7-29 15:30:30	1S	Pwr	Poff stop
004	2011-7-29 15:29:40	2011-7-29 15:30:00	1S	Pwr	Man stop
003	2011-7-29 15:29:10	2011-7-29 15:29:30	1S	Pwr	Poff stop
002	2011-7-29 15:28:40	2011-7-29 15:29:00	1S	Pwr	Poff stop
001	2011-7-29 15:28:10	2011-7-29 15:28:30	1S	Pwr	Poff stop

Record Time: 00000d-00h:2m:00s

Switch Up Down PgUp PgDn Curve Backup

①: Serial number: Serial number of the alarm. The alignment is on the time basis. The nearer the time is, the bigger the serial number is.

②: Start time: Start time of file data record

③: End time: End time of file data record

④: Time interval: Time interval of file record (display the time interval of record combination setting)

⑤: Record triggering: Conditions of file record triggering (display the triggering conditions of record combination setting)

⑥: Status: Display the record status of current file;

The file is recording: The file is recoding data;

Suspension because of power failure: The file stops recording because of power failure on the part of the instrument;

Alarm ending: The file stops recording because of alarm removal;

Timing ending: The file stops recording because the setting time is up.

⑦: Total recording time: Total time duration of file recording

⑧: Progress bar of file storage capacity (Remarks: It will appear when the recording mode of the combination isn't in the circular mode.)

⑨: Operating key:

Press "Switch"to switch to other pictures;

Press "Up"to check the file list upwards;

Press"Down"to check the file list downwards;

Press"PgUp" to check the file list upwards;

Press "PgDn" to check the file list downwards;

Press "Curve" to switch to the historical curve chart in the arrow direction and the corresponding data can be checked; in the historical curve chart, press "Back" to return to the file list;

Press "Backup" to switch to the backup screen and a single historical file or all the files can be backedup.

For more information, refer to Section 5.10 Backup Chart; press "Back"to return to the file list.

Remarks: The list-screen can display 13 file storage records.

### 5. 9 Printing screen (with printing function)

The paperless recorder prints historical data and curve through the RS-232 printing interface serial mini-printer. Baud rate: 4800, data bit: 8, parity check: None

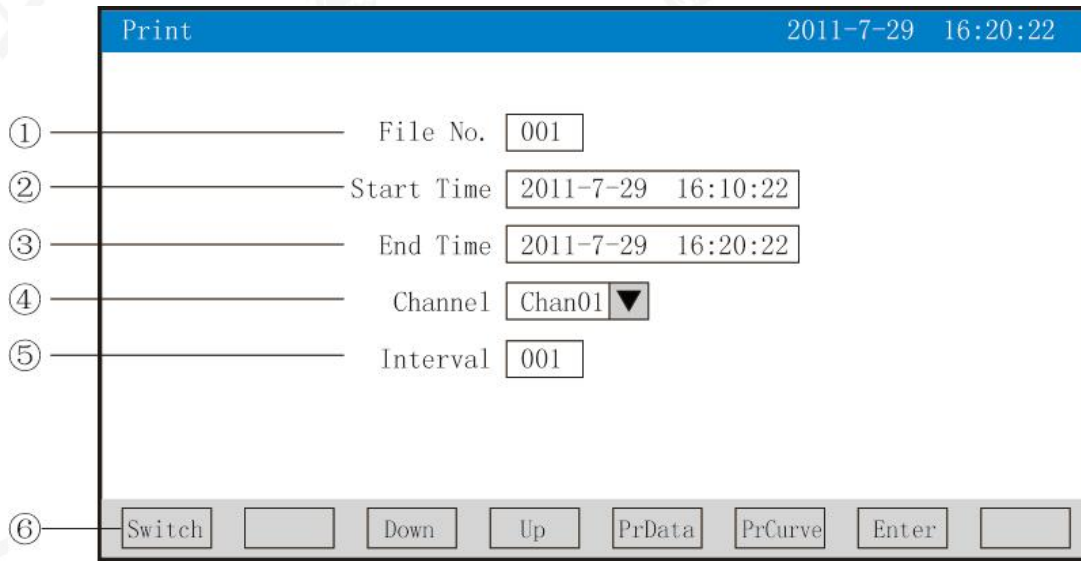

- ①: File serial number: Number for recording file
- ②: Start time: Start time for printing data field
- ③: End time: End time for printing data field
- ④: Printing channel: Choose the printing channel
- ⑤: Printing time interval: Choose the time interval between data printings, unit: Printing time interval \* time interval of recording (only effective on data printing)

⑥: Operating key:

Press "Switch" to switch to other pictures;

press "Up" to move the cursor upwards and press "Enter" to modify the cursor and then press "Enter" to exit;

press "Down" to move the cursor downwards and press "Enter" to modify the cursor and then press "Enter" to exit;

press "PrData" to print data within the set time.

Press "PrCurve" to print curve within the set time.

Wiring schematic diagram of instrument and serial printer:

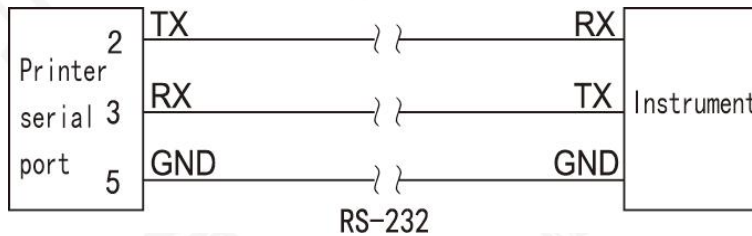

**A:** Manual printing

Press "PrData" or "PrCurve" to print data or curve. Recording format of curve printing:

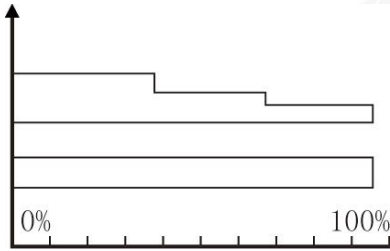

End time : 11-09-24 10-00-00

Start time: 11-09-24 09-58-00

Data printing format:

```

110924142610: 100 ----- Measured value of end time
110924142609: 100
110924142608: 101
110924142607: 100
110924142606: 100
110924142605: 101
110924142604: 101
110924142603: 100
110924142602: 99
110924142601: 100 ----- Measured time of start time

```

CH1: °C ----- Name of channel

**B:** Print the system configuration setting timing printing time interval and start time. When the system time coincides with the time interval, the instrument will print the file automatically.

Format of timing printing:

```

-----
CH48: 100.0°C ----- Measured value of Channel 48
CH47: 100.0°C ----- Measured value of Channel 47
.....
CH2: 100.0°C ----- Measured value of Channel 2
CH1: 100.0°C ----- Measured value of Channel 1
time: 10-02-23 14-36-02 ----- Date and time
-----

```

Note: Data and curve can be printed by manual printing and data by timing printing.

## 5. 10 Picture backup (with the backup function)

The paperless recorder uses USB or SD card to backup and transfer the data in the instrument. Open the operating cover and you can insert the USB or SD card for data backup, for the USB interface is on the front panel and the SD card is on the left of the instrument. SD card with automatic backup function: If the SD card has been inserted into the driver, the instrument will backup the historical data in the recording process to the SD card at 0 clock every day; when recording has been stopped or the triggering conditions set by the user have been satisfied, the instrument will also backup the historical data to SD card automatically. File storage catalog of automatic backup:

1. Storage catalogue of file backup at 0 clock every day: TIMEAUTO (name of file)/ date of instrument

(year/month/day) /time of instrument (hour/minute)

2. Storage catalogue for recording backup suspension: RECAUTO (name of file) /date of instrument (year/month/day) /time of instrument (hour/day). In this operating screen, the user can backup the historical data of all the channels which are recorded in the instrument to USB or SD card. By inputting the backup data into the computer, you can reproduce, analyze and print the data through the upper computer software DTM.

①: Backup contents: Backup a single historical data or all the historical data (selectable)

②: File serial number: Serial number for file recording

③: Start time: Start time for backuping data field

④: End time: End time for backuping data field

(Remarks: Start time and end time are generated by the system automatically. So during the backup of a single historical file, only the start time and end time can be modified for backup; during the backup of all the historical data, the start time and end time cannot be modified.)

⑤: Name of file/name of folder: file name in USB with backup data. During the backup of a single historical file, the suffix of the file is NHD; during the backup of all the historical files, the prefix of the file is F111110

⑥: When the SD card isn't connected, a prompt will be given; when the SD card is connected, no prompt will be given. And corresponding icon will be displayed in the status bar; without UDB connection, by pressing 'Backup', the prompt of no USB will be given; with USB connection, corresponding icon will be displayed in the status bar.

⑦: Operating key:

Press "Switch" to switch to other pictures;

press "Up" to move the cursor upwards and press "Enter" for modification at the cursor and then press "Enter" to exit;

press "Down" to move the cursor downwards and press "Enter" for modification at the cursor and then press "Enter" to exit;

press "Backup" and the prompt of "In backup" will be given by the instrument. When the USB progress bar is full, the prompt of "Backup completion" will be given. If the progress bar is not full, the prompt of "Cancelled" will be given by pressing "Cancel", followed by the termination of data backup.

! Note: By choosing all the historical files, the parameters below will become shady as a prompt, which means the parameters cannot be set.



## 5. 12 Configuration screen

Config 2011-7-29 16:20:22

Password 000000 \*

SYSTEM RECORD

DISPLAY INPUT

OUTPUT ABOUT

Left Right Up Down Enter Exit

The password consists of six digits and “\*”.

Note: If the password is incorrect, the user can fail to enter each configuration screen. The default password is 000000. All the configuration screens are described as follows:

### 5.12.1 System configuration

System 2011-7-29 16:20:22

Language English Password 000000

Time 2011-07-29 16:20:22

CJ Adjust 0.0 23.0°C BurnOut High

Address 001 Baudrate 9600

IP Addr 192.168.000.002 IP Port 0502

Aut Print 0000m Prt Time 00:00

Alm Print OFF

clear data

Left Right Enter Exit

- ★Language selection: Simplified Chinese and English
- ★Password: The user can set the password according to the requirements
- ★Time: “Year-month-day Hour-minute-second” (modifiable)
- ★Cold-junction adjustment: Adjust and display the cold-junction temperature
- ★Disconnection disposal: Low range, high range and previous value maintenance (selectable)
- ★Communication address: Address range: 1-255
- ★Baud rate: 1200, 2400, 4800, 9600, 19200, 38400, 57600 (selectable)
- ★IP address: IP address of Ethernet communication
- ★Port: Port number of Ethernet communication
- ★Timing printing: Setting of timing printing
- ★Start time: Setting start time of timing printing

- ★ Alarm printing: Selection of start and end of printing
- ★ Data removal: Removing all the data in the instrument, including historical data, alarm list, file list and power-off record.

Operation:

Press "Left" and "Right" to move the cursor;  
 press "Down", "Up", "Increase" and "Decrease" to adjust the value;  
 press "Enter" to Enter execution; when the cursor has moved to the data, press "Enter" to pop up the dialogue box of "Delete all the data or not". Select "Yes" to delete data or "No" not to delete data  
 Press "Exit" to exit

### 5.12.2 Record configuration

Record 2011-7-29 16:20:22

Rec Mode Cycle ▼ Rec Int 1s ▼

Rec Type Real ▼

Rec Cond Power ▼

Man Rec Stop ▼

Alm Rec Chan01 ▼ LL ▼

Relay Rec D001 ▼

Time Rec StTime 08:30:00 EndTime 08:40:00

Left Right [ ] [ ] [ ] [ ] Enter Exit

- ★ Record mode: Choose from "no circulation" and "circulation".  
 No circulation: the record process is suspended automatically when the record room of the instrument is full or the quantity of the record files is over 100. Circulation: when the record room is full, it will continue to record historical data from scratch in the means of replacing the old ones with new ones; when the quantity is over 100, the first file will be removed, then the serial number of other files move forward in turn, as a result, new files thus created will continue to record.
- ★ Record intervals: 1second, 2seconds, 4seconds, 6seconds, 15seconds, 1minute, 2minutes, 4minutes left to choose.
- ★ Record types: Real-time, average, maximum, minimum left to choose.  
 Real-time: use the real-time value correspondent to the time of record point.  
 Average: use the average value of real-time data between the record points before and after, and the average value is obtained from weighted average calculation.  
 Maximum: use the maximum value of real-time data between the record points before and after.  
 Minimum: use the minimum value of real-time data between the record points before and after.
- ★ Trigger conditions: choose from manual, electrical, warning, relay and timing (note: from which trigger conditions to choose, the counterpart below can be displayed and modified).  
 Manual trigger: when entering the operator interface of instrument storage, the record of data storage can be started manually.  
 Electrical: after the instrument starts with electricity, new files are established and the data record begins

Warning trigger: it can be set that the record of data storage is switched on only when one channel gives one warning. Stop recording when the warning is over.

Relay trigger: it can be set that the record of data storage is started when one relay give warnings. Stop recording when the warning is over.

Timing trigger: the timing recurrence period is fixed at 24 hours, set the beginning time and closing time so that the instrument does the record of data storage in designated time.

Operation: in the screen,

press "left" and "right" to move the cursor;

press "down", "up", "add", "reduce" to adjust the integral value;

press "Enter" to Enter the execution;

press "quit" to exit the screen, a Enter dialogue box of "the above modifications will stop the current record and start new file record" will pop up, press "Enter" to quit.

### 5.12.3 Display configuration

Display configuration screen showing settings for Display OFF (Never), Loop Tim (4s), Group (Group1), Enable (YES), and six curves (Curve1 to Curve6) with channel selections (Chan01 to Chan06) and color selections (Red, Yellow, Green, Blue, Purple, Brown). Navigation buttons (Left, Right, Enter, Exit) are visible at the bottom.

★Close liquid crystal display: select from in 5minutes, in 10minutes, in 30minutes, in 1hour, never

★Recurrence intervals: display the interval time of next combination, select from 4seconds, 8seconds, 15seconds, 30seconds

★Curve combination: each curve combination may include 6 curve lines, and there are 10 curve combinations to choose. Choose according to actual needs, and then display it in real-time curve picture

★Enable: select "yes", then correspondent curve will be displayed in the real-time curve picture, select "no", and then it cannot be displayed

★Curve one to six: choose the channel to be displayed, whether to display curve colors or not

Operation:

Press "left" and "right" to move the cursor in the screen;

Press "down", "up", "front", "behind" to select contents needed;

Press "Enter" to Enter the execution;

press "quit" to quit the screen.



- ★ Unit: it symbolizes the project unit correspondent to display channel, refer to 5.12.4.2 the introduction of “unit” input method to get designing method
- ★ Range: record the maximum and minimum range of data, the coverage is -9999-9999, the digit of decimal point in the channel can be decided by changing the digit number of maximum range.
- ★ Accumulate: choose “yes ” or “no”, it is only used in the calculation of traffic accumulation
- ★ Filter time: revise sample frequency of the instrument to prevent display value of measurement from jumping. Range: 0-9.9seconds. Examples for relationships between display value of the instrument and filter time: when the analog range is inputted, providing that the filter time is 3.0 seconds, the instrument (filter time 3×sample period 1second)averages the sample value within 3seconds automatically, then updates the display value in recursive method.
- ★ Excision of small signal: measurement value < (maximum range – minimum range) \* percentage of small signal excision + minimum range, the instrument displays the minimum range for the time being, the excision function of small signal is closed when it is set 0. Range: 0-99.9%
- ★ Linear revision: The quantity of the project is linear revised by Formula  $y = Kx + b$ , of which K symbolizes linear factor, b symbolizes zero point revision. In default status, K=1.0, b=0.0, the revision is not needed. x represents the amount of project the channel should display before revision, y represents the display value of channel after revision.
- ★ Super-low temperature LL of the channel, minimum L, maximum H, super-high temperature HH warning, hysteresis error numbers, please heed several points listed below:

Super-low temperature, minimum, maximum, super-high temperature and hysteresis error numbers, both of which the setting range is -9999-9999, input method is equivalent to that of range.

Warning function: OFF: close the warning function, ON: open the warning function.

Alarm contacts: choose relay contacts, serial Numbers, D001 to D018 corresponding number 1 to 18 relay contacts output, "nothing" said don't output.

Operation:

Press “left” and “right” to move the cursor in the screen;

Press "down", “up”, “front”, “behind” to select contents needed;

Press “Enter” to Enter the execution;

Press“quit” to quit the screen.(when any of the digit number, signal type, unit, range is revised, press “quit” will trigger a dialogue box of storage reminder, press “Enter” to quit)

Press “copy” “paste” to copy the parameter of configuration channel number needed to other channels, for instance: if you need to copy the parameter of Channel 01 to Channel 02, you can press “copy” when then configuration channel is channel 01, then change the configuration channel into channel 02 and press “paste”. When several channel configurations are of the same, the function will reduce configuration time immensely.

#### 5.12.4.1 Introduction to the input method of “digit number” in channel configuration:

The input method adopted in the instrument is T6 input method which resembles the keyboard input method used in mobile phones. It has simple operation and is easy to learn, you can input Chinese characters, numbers, words and special symbols by minimum keyboard operations. The input problems of digit number of Chinese characters as well as special unit are solved by adopting international code.

When the cursor moves to “digit number”, the input method screen below will be displayed after pressing “Enter”.

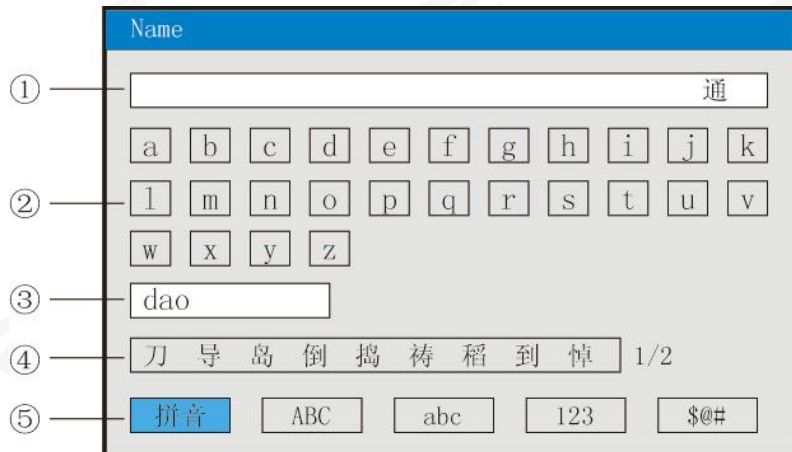

①: Input display bar: display input unit symbol

②: Soft keyboard: when input pinyin letters, 26 pinyin letters are displayed

When input capital letters, 26 capital letters are displayed

When input lowercase letters, 26 lowercase letters are displayed

When input numbers, (0-9), short traverse lines and decimal points are displayed

When input special symbols, 30 special symbols are displayed

③: Pinyin combination display bar (appears only in pinyin input method)

④: Characters alternative bar (appears only in pinyin input method)

⑤: Selection bar for input method, choose needed input method here

⑥: Operation key:

Press "left", "right" and "up" to move the cursor to choose symbols needed

Press "cursor": move the cursor to the selection bar of input method to switch input method; press "cursor"

when there is characters alternative bar, ▲ will appear, then press "left", "right" to select symbols needed

Press "delete" to delete characters where the cursor resides

Press "select" to select characters where the cursor resides

Press "complete" to quit the input method, complete inputting digit number

Press "cancel" to quit the input method screen

#### A. Pinyin input method screen

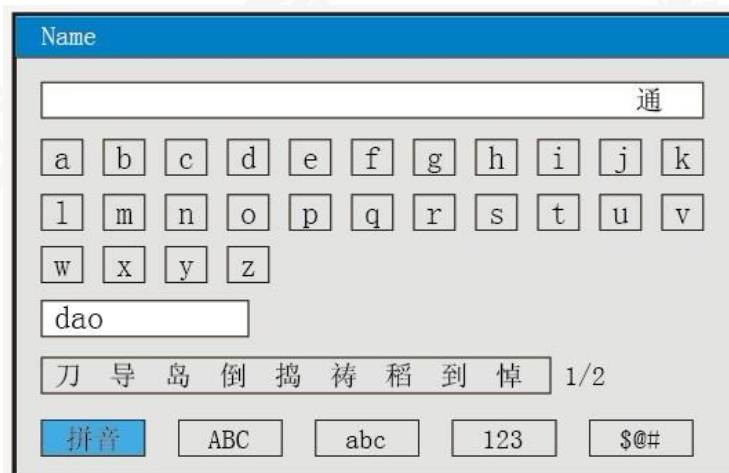

Use pinyin input method screen: pinyin input method represents the Chinese phonation in the way of pinyin.

Input Chinese character "道"

1. Press "Enter" to enter input method screen (pinyin input method in tacit recognition)
  2. Press "left", "right" and "up" to move the cursor to choose pinyin letter "d"
  3. Press "select" to select, the display bar of pinyin combination will display "d"
  4. Press "left", "right" and "up" to move the cursor to choose pinyin letter "a"
  5. Press "select" to select, the display bar of pinyin combination will display "da"
  6. Press "left", "right" and "up" to move the cursor to choose pinyin letter "o"
  7. Press "select" to select, the display bar of pinyin combination will display "dao"
  8. Preselected Chinese character "道" will display in the alternative bar of characters
  9. Press "cursor", below the alternative bar of characters will display ▲
  10. Press "left", "right" to select Chinese character "道"
  11. Press "select" to input, the input bar will display Chinese character "道"
- Note: when the number of homophonic Chinese characters is over 9, press "right" to move to the next page

### B. Screen of capital letters input method

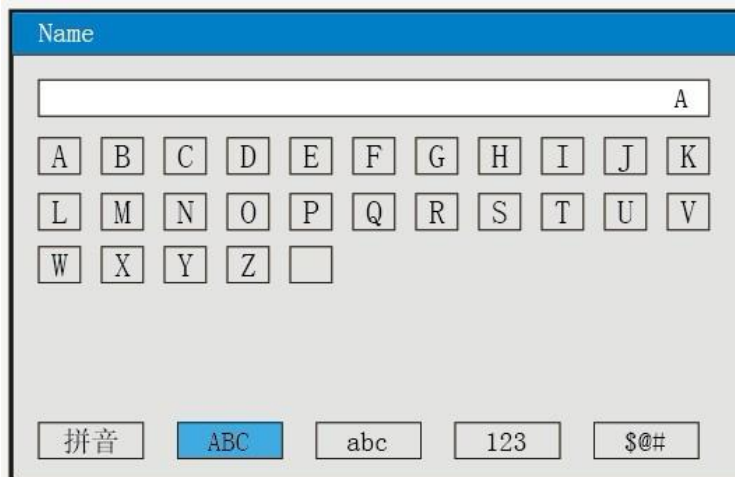

Input capital letters "A"

1. Press "Enter" to enter input method screen
2. Press "cursor" to move the cursor to the selection bar of input method
3. Press "left", "right" to move the cursor
4. Press "cursor" to move the cursor to the soft keyboard bar for capital letters input
5. Press "select" to select, the input bar will display "A"
6. Press "complete" to quit the input method, complete the input of digit number

### C. Screen of lowercase letters input method

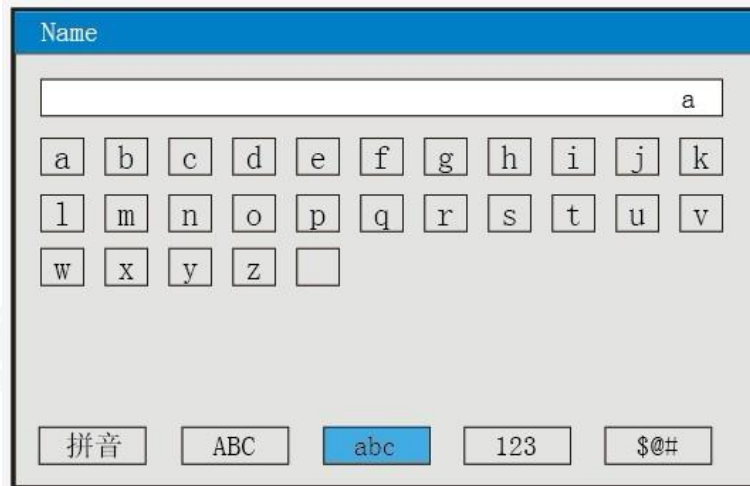

Input capital letters "a"

1. Press "Enter" to enter input method screen
2. Press "cursor" to move the cursor to the selection bar of input method
3. Press "left", "right" to move the cursor
4. Press "cursor" to move the cursor to the soft keyboard bar for capital letters input
5. Press "select" to select, the input bar will display "a"
6. Press "complete" to quit the input method, complete the input of digit number

#### D. Number input screen

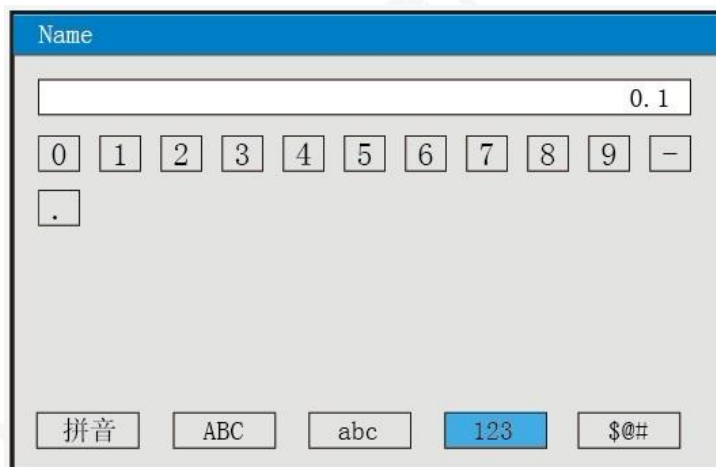

Input number "0.1"

1. Press "Enter" to enter input method screen
2. Press "cursor" to move the cursor to the selection bar of input method
3. Press "left", "right" to move the cursor
4. Press "cursor" to move the cursor to the soft keyboard bar for capital letters input
5. Press "select" to select, the input bar will display "0"
6. Press "left", "right" and "up" to move the cursor to select "."
7. Press "select" to select, the input bar will display "0."
8. Press "left", "right" and "up" to move the cursor to choose "1"
9. Press "select" to select, the input bar will display "0.1"

10. Press “complete”to quit the input method, complete the input of digit number

#### E. Screen of special symbols input method

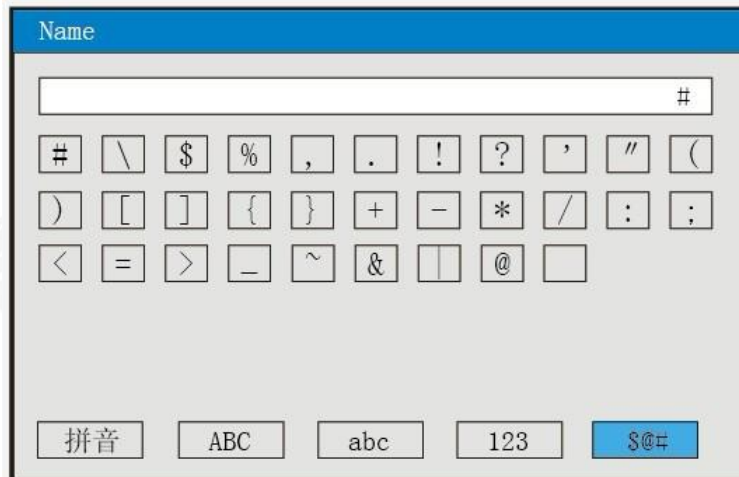

Input capital letters “#”

1. Press “Enter” to enter input method screen
2. Press “cursor” to move the cursor to the selection bar of input method
3. Press “left”, “right” to move the cursor
4. Press “cursor” to move the cursor to the soft keyboard bar for capital letters input
5. Press “select” to select, the input bar will display “#”
6. Press “complete”to quit the input method, complete the input of digit number

#### 5.12.4.2 Introduction to the input method of “unit” in channel configuration:

When the cursor moves to “unit”, the input method screen below will appear after pressing “Enter”

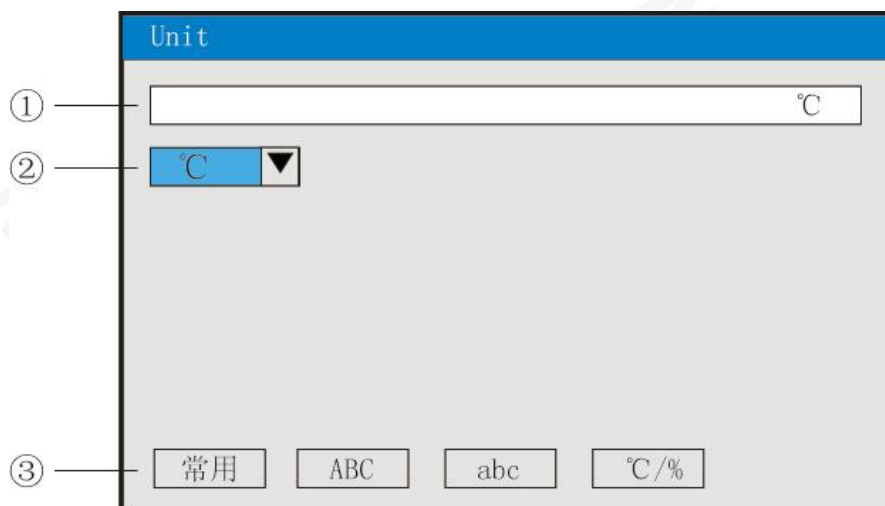

① : Input display: display the input character

② : Soft key: Common input,

Large character input for displaying 26 capitals.

Display 26 characters for small letters

Display 16 characters for special input method.

③ : Input method selection column, select input method here.

④ : Operation key:

Press “left”, “right”, “upper” to select the desirable

Press “cursor” shift the cursor to shift the input method.

Press “delete” to delete the character,

Press “finish” to exit, and complete unit input

Press “cancel” to exit.

#### A. Screen of common unit input method

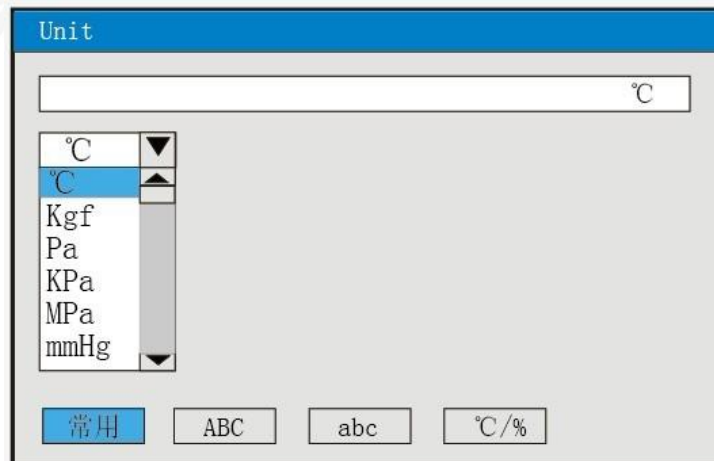

Input common unit “°C”

1. Press “Enter” to enter unit input method screen(common unit input method in tacit recognition)
2. Press“Enter” will elicit pull-down frame of common unit. Common units are °C , Kgf , Pa, KPa, MPa, mmHg, mmH<sub>2</sub>O, bar, t/h, Kg/h, L/h, m<sup>3</sup>/h, Nm<sup>3</sup>/h, t/m, Kg/m, L/m, m<sup>3</sup>/m, Nm<sup>3</sup>/m, t/s, Kg/s, L/s, m<sup>3</sup>/s, Nm<sup>3</sup>/s, t, Kg, g, Nm<sup>3</sup>, m<sup>3</sup>, L, KJ/h, KJ/m, KJ/s, MJ/h, MJ/m, MJ/s, GJ/h, GJ/m, GJ/s, KJ, MJ , GJ , V, A, KW, HZ, %, mm, rpm
3. Press “down”, “up”, “next”, “front” to choose unit “°C” needed
4. Press “Enter” to Enter, the input bar of common unit will display “°C”
5. Press “select” to select, the input bar will display “°C”
6. Press “complete” to quit the input method, complete the input of digit number

#### B. Capital input interface

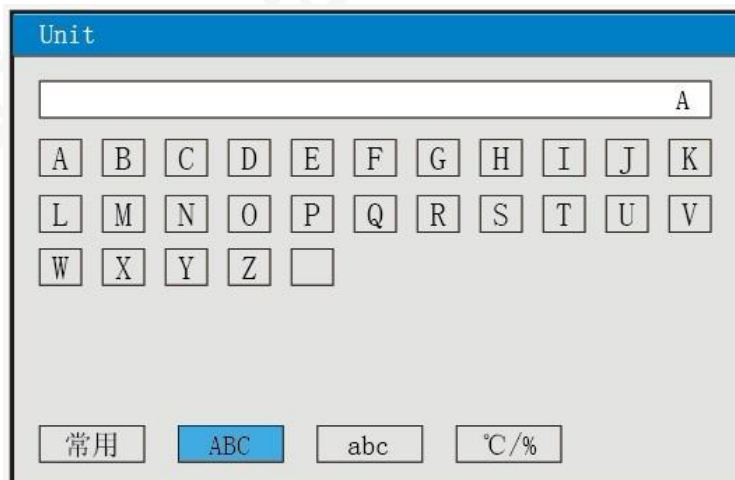

Input the capital character “A”

1. Press “OK” to enter into the interface

2. Press "cursor" to shift to the input selection
3. Press "left", "right" to move the cursor
4. Press "Cursor" to shift the capital to software column
5. Press "Select" and input to display "A"
6. Press "Finish" to exit and finish the input of number.

### C. Small letter input interface

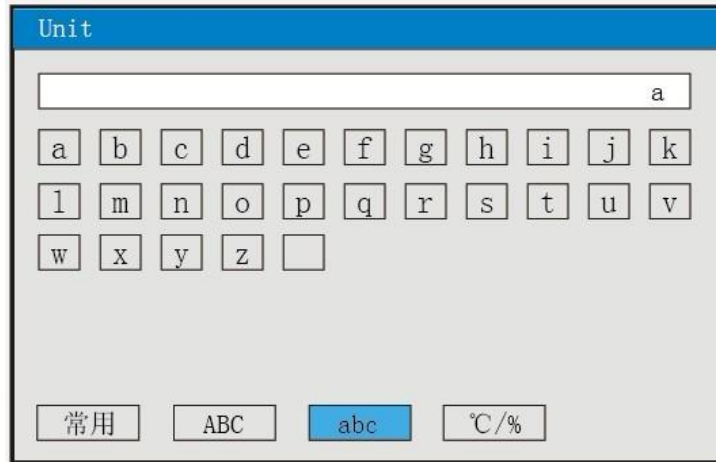

Input the Small letter "a"

1. Press "OK" to enter into the interface
2. Press "cursor" to shift to the input selection
3. Press "left", "right" to move the cursor
4. Press "Cursor" to shift the capital to software column
5. Press "Select" and input to display "a"
6. Press "Finish" to exit and finish the input of number.

### D. Digital input interface

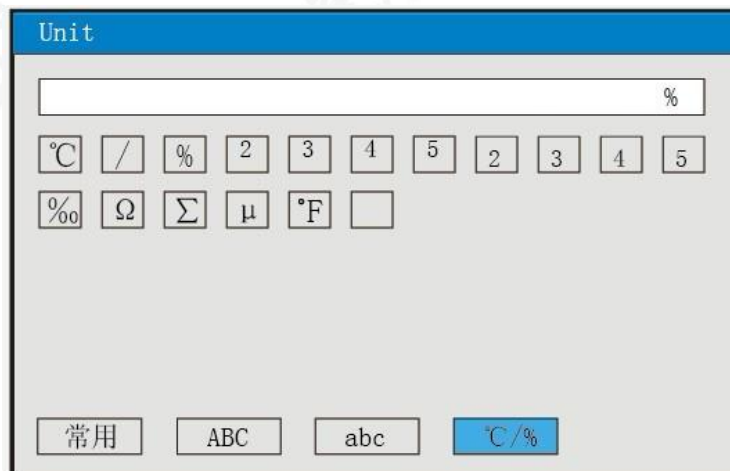

Special character "%"

1. Press "OK" to enter into the interface

2. Press "cursor" to shift to the input selection
3. Press "left", "right" to move the cursor
4. Press "Cursor" to shift the capital to software column
5. Press "Select" to display "%"
6. Press "Finish" to exit and finish the input of number.

### 5.12.5 Analog output

Output		2011-7-29 16:20:22				
Channel:	<input type="text" value="01-06"/>					
	Input	Type	Low	High	kx+b:b	kx+b:k
AOut01:	<input type="text" value="Chan01"/>	<input type="text" value="4-20mA"/>	<input type="text" value="0.0"/>	<input type="text" value="100.000"/>	<input type="text" value="0.0"/>	<input type="text" value="1.000"/>
AOut02:	<input type="text" value="Chan02"/>	<input type="text" value="4-20mA"/>	<input type="text" value="0.0"/>	<input type="text" value="100.000"/>	<input type="text" value="0.0"/>	<input type="text" value="1.000"/>
AOut03:	<input type="text" value="Chan03"/>	<input type="text" value="4-20mA"/>	<input type="text" value="0.0"/>	<input type="text" value="100.000"/>	<input type="text" value="0.0"/>	<input type="text" value="1.000"/>
AOut04:	<input type="text" value="Chan04"/>	<input type="text" value="4-20mA"/>	<input type="text" value="0.0"/>	<input type="text" value="100.000"/>	<input type="text" value="0.0"/>	<input type="text" value="1.000"/>
AOut05:	<input type="text" value="Chan05"/>	<input type="text" value="4-20mA"/>	<input type="text" value="0.0"/>	<input type="text" value="100.000"/>	<input type="text" value="0.0"/>	<input type="text" value="1.000"/>
AOut06:	<input type="text" value="Chan06"/>	<input type="text" value="4-20mA"/>	<input type="text" value="0.0"/>	<input type="text" value="100.000"/>	<input type="text" value="0.0"/>	<input type="text" value="1.000"/>
Left		Right			Enter	Exit

- ★Output channel: 01-06, 07-12 channels available
- ★Input channel: output channel is corresponding to the input channel, such as: "output 02" corresponds to the "channel 05", the No.2 analog output channel corresponds to channel 5 transformation output.
- ★Output type: 0-10 mA,0-20 mA,4-20 mA,0-5V,1-5V,0-10V are available, none
- ★Output lower limit, output upper limit: adjust the upper and lower range of transformer output ,which scope is -9999-19999, Enter the channel decimal point upon modification of the range.
- ★kx+b: Analog output linear modifier formula, b: output zero moving quantity, k: output amplification proportion.

Operation: in the interface

Press "left", and "right" to shift cursor;

Press "Lower", "Upper", "Up" and "Down" to select the desirable content;

Press "OK" to Enter;

Press "Ok" to exit

## 5.12.6 Function list

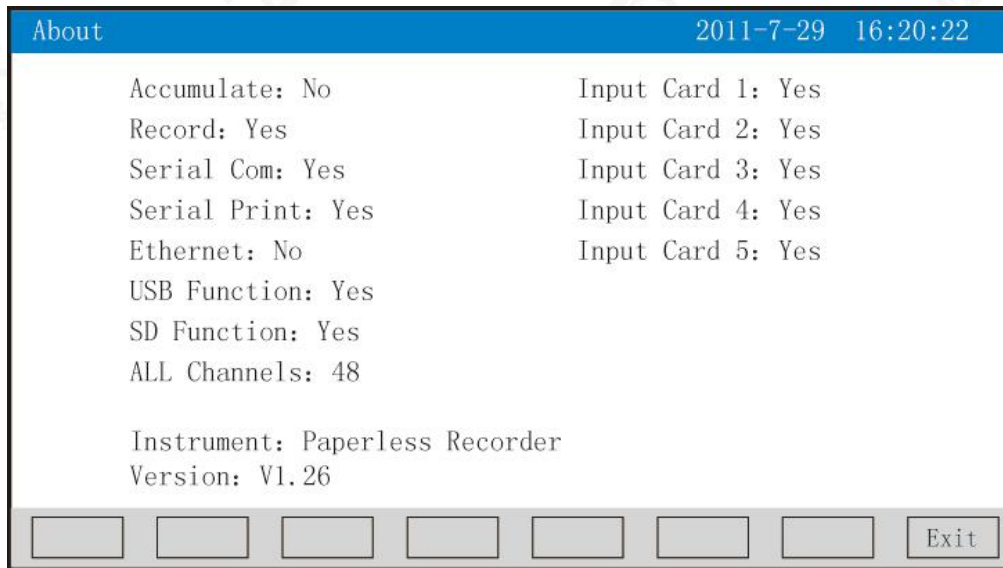

★Check the instrument list, which displays the instrument functions at a glance. It shows “Yes” or “No”.  
Operation: on the interface, press “Exit” to exit the interface.

## VI. Communication

The instrument is able to communicate with the upper computer which has function of parameter set-up, data acquisition, monitoring of the lower computer. It can coordinate with industrial software to display dynamic screen, set up instrument data, generate diagram, record disk memory, and print inventory report under the window system in Chinese. Also, it is capable of getting real-time data and curves, and record historical data and curves which can be elicited for data processing in Excel through upper computer management software of our company. The instrument three kinds of standard interface which can communicate with the upper computer, RS-232, RS-485 and EtherNet .

★The RS-232 means only permits one upper computer with one recording instrument; it can be applied to read data of the recording instrument for customers using portable machines. It is able to connect with wireless radio modem to carry on remote wireless transmission or with serial micro-printer to printer data and curves.

★The RS-485 means permits one upper computer with several recording instruments at the same time, it is applied to users with terminals to establish network with the recording instrument to receive data of the recording instrument and connect with all kinds of controlling systems in real-time.

★The EtherNet communication allow several instruments to develop networks with the upper computer, it can switch data at the speed of 10M, which can carry on a large mount of data communications between the terminal and the instrument. When the distance is over 300m, the communication is realized in the means of fiber network. You just need to select the IP Address and do some set-ups in the computer management software in the system configuration of the recording instrument to start EtherNet communication.

**Refer to Table 1 and 2 for specific parameters**

Table 1: Corresponding address table for register to 0x04 reading command



7	7	No.1 and No.2 bytes of IP	Short	Read-write	For example: If the IP address is 192.168.100.2, the two bytes of the register from the top to the bottom are 192 and 168.
8	8	No. 3 and No.4 bytes of IP address	Short	Read-write	The two bytes of the register from the top to the bottom are 100 and 2 as the above example.
9	9	Ethernet port number	Short	Read-write	
10	10	Time interval of printing	Short	Read-write	
11	11	Hour of start time	Char	Read-write	
12	12	Minute of start time	Char	Read-write	
13	13	Alarm printing	Char	Read-write	0:End 1:Start
14	14	Number of input channel	Char	Write only	Range: 0 ... 59 corresponds to channel 1 ... 60 (Remarks 1)
15	15	No.1 and No.2 characters of location number	Short	Write only	Refer to 'Channel Parameters' of the operating instructions: Location number and Chinese character in the unit should be displayed by ASCII code.
16	16	No.3 and No.4 characters of location	Short	Write only	
17	17	No.5 and No.6 characters of location number	Short	Read-write	
18	18	No.7 and No.8 characters of location number	Short	Read-write	
19	19	Type of input	Char	Read-write	
20	20	No.1 and No.2 character of unit	Short	Read-write	
21	21	No.3 and No.4 character of unit	Short	Read-write	
22	22	No.5 and No.6 character of unit	Short	Read-write	

No.	Input register address (decimal system)	Parameters name	Type of data	Type	Remarks
23	23	Decimal point of channel	Char	Read-write	
24	24	Lower limit of range	Float	Read-write	
25	26	Upper limit of range	Float	Read-write	
26	28	Cumulative function	Char	Read-write	
27	29	Filtering coefficient	Char	Read-write	It is ten times of the parameter.
28	30	Signal removal	Short	Read-write	It is ten times of the parameter.

29	31	Linear modifying proportion coefficient k	Float	Read-write	Refer to 'Channel Parameters' of operating instructions.
30	33	Linear modifying zero coefficient b	Float	Read-write	
31	35	Alarm function	Char	Write only	0...3 corresponds to: Low-low limit, low limit, high limit and high-high limit (Remarks 2)
32	36	Alarm function	Char	Read-write	0: OFF 1: ON
33	37	Alarm contact	Char	Read-write	
34	38	Alarm value	Float	Read-write 写	
35	40	Alarm return difference	Float	Read-write	
36	42	Number of input channel	Char	Write only	Range: 0...11 (Remarks 3)
37	43	Input channel	Char	Read-write	Range: 0...59 corresponds to 1...60 (Remarks 1)
38	44	Type of output	Char	Read-write	0...6 corresponds to the output type: None ... (0-10V)
39	45	Low limit of output	Float	Read-write	Refer to 'Output Parameters' of operating instructions.
40	47	High limit of output	Float	Read-write	
41	49	Output modifying proportion coefficient k	Float	Read-write	
42	51	Output modifying zero coefficient b	Float	Read-write	
43	53	Power off LCD	Char	Read-write	0...4 corresponds to the parameters: 5 minutes ...never
44	54	Time of circular display	Char	Read-write	0 — 3 corresponds to the parameters 4-30 seconds 0 — 3
45	55	Number of curve combination	Char	Write only	0...9 corresponds to 1...10 curve combination.
46	56	Start or not	Char	Read-write	0: No 1: Yes
47	57	Curve number	Char	Write only	0...5 correspond to 1...6 curve number; one combination consists of 6 curves.
48	58	Channel number of curve	Char	Read-write	Range: 0...59 corresponds to 1...60 (Remarks 1)
49	59	Curve display or not	Char	Read-write	0:No 1:Yes
50	60	Curve color	Char	Read-write	0...5 corresponds to: Red...brown
51	61	Mode of recording	Char	Read-write	0:Circulation 1: No circulation

52	62	Time interval of record	Char	Read-write	0...8 corresponds to 1 second ... 4 minutes.
53	63	Type of record	Char	Read-write	0...3 corresponds to real-time value...minimum value.
54	64	Triggering conditions	Char	Read-write	0...4 corresponds to manual operation... timing.
55	65	Manual triggering	Char	Read-write	0:Stop : 1Start
56	66	Input channel of alarm triggering	Char	Read-write	Range: 0 ... 5 9 corresponds to channels 1...60 (Remarks 1)
57	67	Alarm type of alarm triggering	Char	Read-write	0...3 corresponds to low-low limit...high-high limit.
58	68	Relay location number of relay triggering	Char	Read-write	Corresponds to alarm contacts ALM1...ALM18.
59	69	Start of timing triggering: hours	Char	Read-write	Refer to 'Record Parameters' of the operating instructions.
60	70	Start of timing triggering: minutes	Char	Read-write	
61	71	Start of timing triggering: seconds	Char	Read-write	
62	72	End of timing triggering: hours	Char	Read-write	
63	73	End of timing triggering: minutes	Char	Read-write	
64	74	End of timing triggering: seconds	Char	Read-write	

Note:

1. The 60-channel input parameters of should share the same register address. The input channel number (register address 14) decides which channel the parameters belong to. For this reason when reading and writing the channel parameters, the channel number should be first entered.
2. Each input channel consists of four alarm types (low-low limit alarm, low limit alarm, high limit alarm and high-high limit ), which share the same register address. Which alarm type the parameters belong to is based on the alarm type (register address 35). For this reason the alarm type should be entered in order to read and write the parameters of some channel.
3. The 12-channle parameters share the same register address. Which channel the parameters belong to is based on the channel number. For this reason when reading and writing the channel parameters, the channel number should be first entered.

## VII. Instrument parts

Operating Instructions	1
Certificate of Inspection	1
Support installation	4
Screwdriver	1
Disk	1

USB	1
SD card	1